



F160 SERIES

In line high pressure filters
elements according to DIN 24550

Inline filters for operating pressure up to 160 bar, flow rate up to 400 l/min.

Available with or without bypass, indicator port is a standard option to fit a visual or electrical differential indicator.

TECHNICAL INFORMATION

HOUSING

tested according to NFPA T3.10.5.1 , ISO3968

HYDRAULIC SYMBOL:



PRESSURE:

Max operating: 160 bar
Burst: 480 bar

CONNECTION PORTS:

G 1/2" ÷ 1 1/2"

MATERIALS:

Head: cast iron
Bowl: aluminium alloy
Seal: NBR (FKM on request)

BYPASS:

No by-pass or 6 bar setting

ELEMENT

type DIN 24550, tested according to ISO 2941, 2942, 2943, 3968, 16889, 23181

FILTER MEDIA:

Inorganic microfiber: G03 - G06 - G10 - G15 - G25
Paper: C10

DIFFERENTIAL COLLAPSE PRESSURE:

21 bar or 210 bar

OPERATING TEMPERATURE RANGE:

-25°C +100°C

FLUID COMPATIBILITY:

Full with HH-HL-HM-HV (acc. To ISO 2943).
For use with other fluid please contact Filtrac Customer Service
(info@filtrac.it).

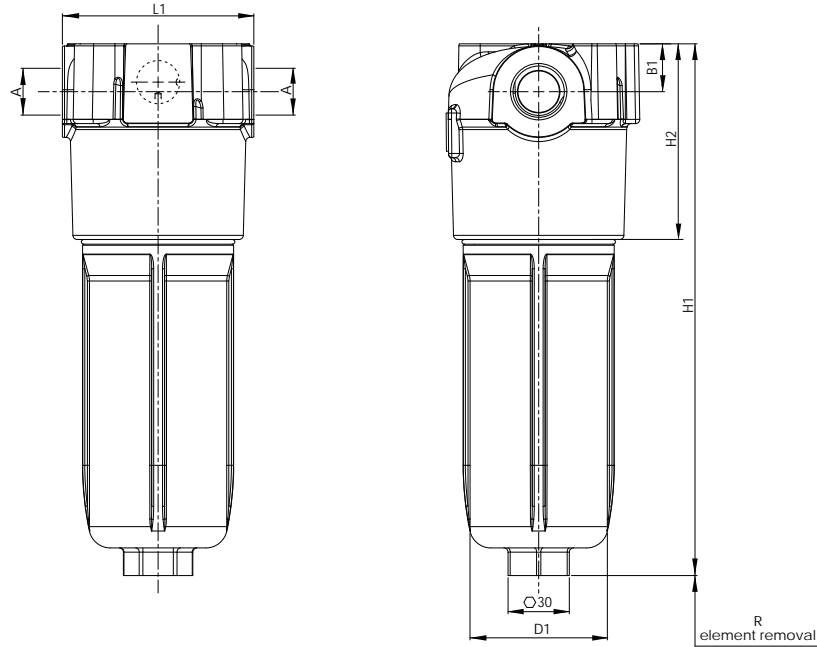
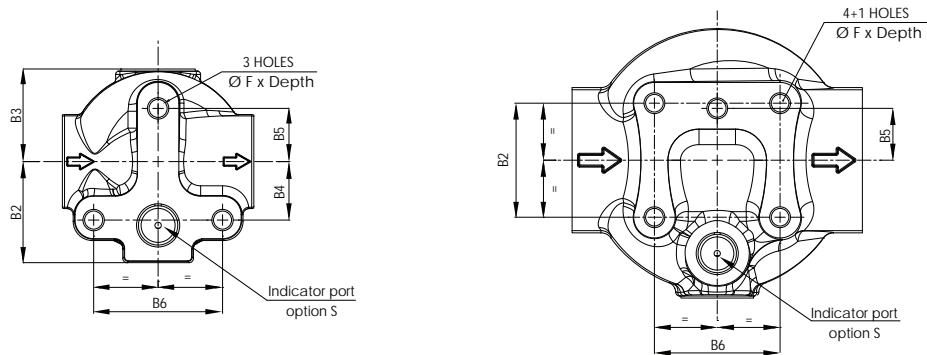
OVERALL DIMENSIONS

F160-XD160/250/400

NOMINAL SIZE

MODEL	A	B1	B2	B3	B4	B5	B6	D1	F	H1	H2	L1	R	WEIGHT
F160-XD040	G 1/2"									180				2,4 Kg
F160-XD063	G 3/4"	22,5	47,5	43,5	27,5			65		250	92	90	110	2,6 Kg
F160-XD100	G 1"									329				2,8 Kg
F160-XD160						25	60,6		M10x15	289				6,6 Kg
F160-XD250	G 1 1/4"	40	55	---	---			110		361	129	140	130	7 Kg
F160-XD400	G 1 1/2"									514				10 Kg

ORDERING INFORMATION

	1.	2.	3.	4.	5.	6.	7.	8.	9.	10.
	F160	XD	100	G10	A	B	B3	D	W	E05
SPARE ELEMENT		XD	100	G10	A					

1. FILTER SERIES	F160	
2. FILTER ELEMENT SERIES	XD	
3. FILTER SIZE	040-063-100	
	160-250-400	
4. FILTER MEDIA	000	no element
	G03	glassfiber $\beta_{4,5\mu\text{m(c)}} > 1.000$
	G06	glassfiber $\beta_{7\mu\text{m(c)}} > 1.000$
	G10	glassfiber $\beta_{12\mu\text{m(c)}} > 1.000$
	G15	glassfiber $\beta_{18\mu\text{m(c)}} > 1.000$
	G25	glassfiber $\beta_{22\mu\text{m(c)}} > 1.000$
	C10	paper $\beta_{10\mu\text{m(c)}} > 2$ only for Dp 21 bar
5. ELEMENT COLLAPSE	A	21 bar
	B	210 bar recommended with no by-pass option
6. SEALS	B	NBR
	V	FKM
7. CONNECTIONS	B3	G 1/2"
For different thread options please check availability with Filtrac Customer Service.	B4	G 3/4" for sizes 040-063-100
	B5	G 1"
	B6	G 1 1/4" for sizes 160-250-400
	B7	G 1 1/2"
8. BYPASS VALVE	0	no by-pass
	D	6 bar
9. INDICATOR PORT OPTION	S	with metal plug
	W	with plastic plug when using an indicator
10. INDICATOR	000	no indicator
	V05	differential visual 5 bar
	E05	differential electrical 5 bar
	V08	differential visual 8 bar
	E08	differential electrical 8 bar no bypass version only
ACCESSORIES	LC24	LED connector

The accessories must be ordered separately

PRESSURE DROP (Δp) INFORMATION FOR FILTER SIZING

The total Delta P through a filter assembly is given from Housing Δp + Element Δp .

This ideally should not exceed 1,0 bar and should never exceed 1/3 of the set value of the by-pass valve. N.B. All the reported data have been obtained at our laboratory, according to specification ISO3968 with mineral oil having 32 cSt viscosity and density 0,875 Kg/dm³.

HOUSING PRESSURE DROP

The housing Δp is given by the curve of the considered model and port, in correspondence of the flow rate value.

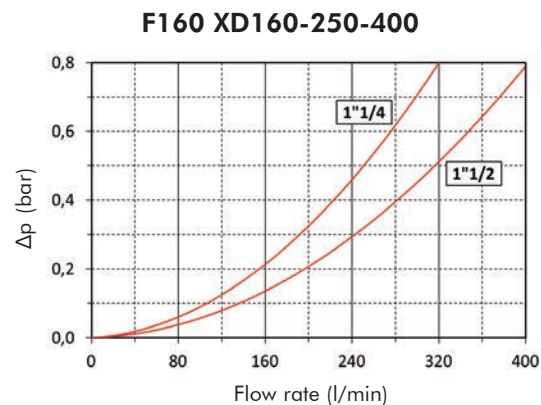
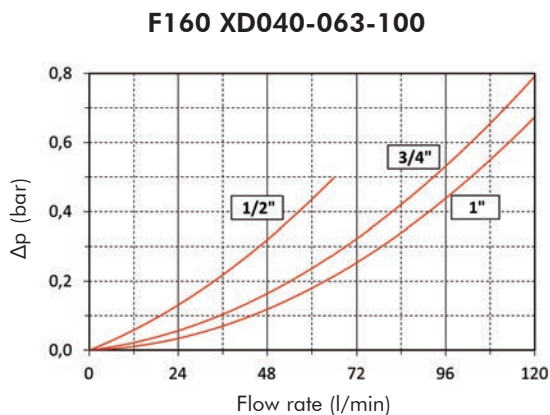

ELEMENT PRESSURE DROP (filter elements 21 bar collapse)

The element Δp (bar) is given by the flow rate (l/min) multiplied by the factor in the table here below corresponding to the selected media and divided by 1000.

If the oil has a viscosity V_x different than 32 cSt a corrective factor $V_x/32$ must be applied.

Example: 80 l/min with XD063G25A and oil viscosity 46 cSt $> 80 \times 4,62/1000 \times 46/32 = 0,53$ bar

	G03A	G06A	G10A	G15A	G25A	C10A
XD040	22,00	15,00	8,75	7,50	6,25	5,00
XD063	16,15	10,00	6,15	5,38	4,62	3,85
XD100	12,00	6,50	4,00	3,50	3,00	2,00
XD160	7,81	4,96	2,92	2,04	1,66	0,94
XD250	5,20	2,90	1,86	1,01	0,96	0,58
XD400	3,25	1,69	1,24	0,71	0,64	0,36

EXAMPLE OF TOTAL Δp CALCULATION

F160XD063G25ABB5DWV05 with 80 l/min and oil 46 cSt:

Housing Δp 0,3 bar + element Δp 0,53 bar ($80 \times 4,62/1000 \times 46/32$) = total assembly Δp 0,83 bar

ELEMENT PRESSURE DROP (filter elements 210 bar collapse)

The element Δp (bar) is given by the flow rate (l/min) multiplied by the factor in the table here below corresponding to the selected media and divided by 1000.

If the oil has a viscosity V_x different than 32 cSt a corrective factor $V_x/32$ must be applied.

Example: 80 l/min with XD100G25B and oil viscosity 46 cSt $> 80 \times 5,5/1000 \times 46/32 = 0,63$ bar

	G03B	G06B	G10B	G15B	G25B
XD040	34,97	25,00	16,25	13,75	11,25
XD063	29,23	18,46	11,54	9,62	7,69
XD100	19,00	11,50	7,50	6,50	5,50
XD160	8,13	5,00	3,75	3,13	2,50
XD250	5,40	3,40	2,80	2,40	2,00
XD400	3,38	2,16	1,75	1,44	1,13

EXAMPLE OF TOTAL Δp CALCULATION

F160XD100G25BBB5DWV08 with **80** l/min and oil **46** cSt :

Housing Δp 0,3 bar + element Δp 0,63 bar ($80 \times 5,5/1000 \times 46/32$) = total assembly Δp 0,93 bar

BYPASS VALVE PRESSURE DROP

The bypass valve Δp is given by the curve of the considered model and setting, in correspondence of the flow rate value.

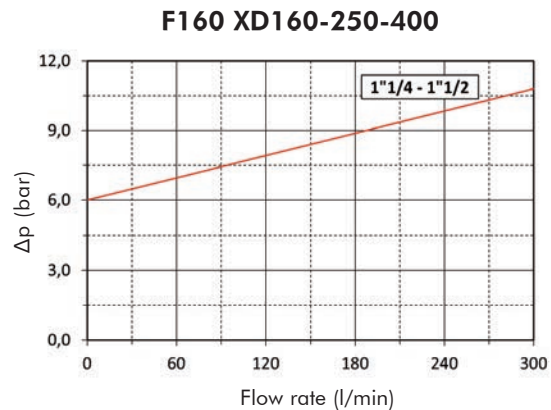
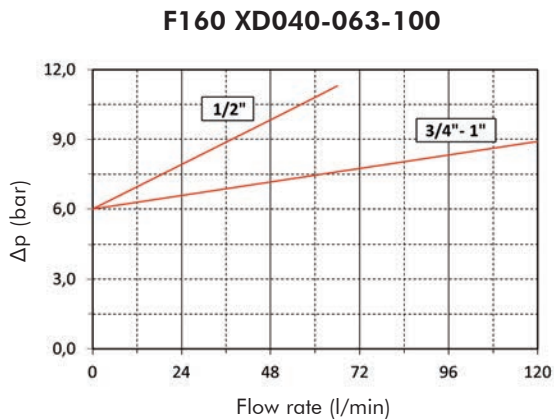

N.B. All the reported data have been obtained at our laboratory, according to specification ISO3968 with mineral oil having 32 cSt viscosity and density 0,875 Kg/dm³.

USER TIPS



- 1 FILTER HEAD
- 2 INDICATOR PORT
- 3 FIXING HOLES
- 4 BY- PASS VALVE
- 5 FILTER ELEMENT
- 6 FILTER BOWL
- 7 SEAL KIT
- 8 IDENTIFICATION LABEL

INDICATOR TIGHTENING TORQUE

V05/E05/V08/E08	50 Nm
-----------------	-------

SPARE SEAL KIT PART NUMBER

	NBR	FKM
F160 XD040-063-100	06.021.00090	06.021.00135
F160 XD160-250-400	06.021.00096	06.021.00114



WARNING

-  Make sure that Personal Protective Equipment (PPE) is worn during installation and maintenance operation.

DISPOSAL OF FILTER ELEMENT

-  The used filter elements and the filter parts dirty of oil are classified as "Dangerous waste material": they must be disposed according to the local laws by authorized Companies.



INSTALLATION

-  1. the IN and OUT ports must be connected to the hoses in the correct flow direction (an arrow shows on the filter head (1))
- 2. the filter housing should be preferably mounted with the bowl (6) downward
- 3. secure to the frame the filter head (1) using the threaded fixing holes (3)
- 4. verify that no tension is present on the filter after mounting
- 5. enough space must be available for filter element replacement
- 6. the visual clogging indicator must be in a easily viewable position
- 7. when a electrical indicator is used, make sure that it is properly wired
-  8. never run the system with no filter element fitted
- 9. keep in stock a spare FILTREC filter element for timely replacement when required

OPERATION

-  1. the filter must work within the operating conditions of pressure, temperature and compatibility given in the first page of this data sheet
- 2. the filter element must be replaced as soon as the clogging indicator signals at working temperature (in cold start conditions, oil temperature lower than 30°C, a false alarm can be given due to oil viscosity)
- 3. If no clogging indicator is mounted, replace the element according to the system manufacturer's recommendations

MAINTENANCE

-  1. make sure that the system is switched off and there is no residual pressure in the filter
- 2. unscrew the bowl (6) by turning it anti-clockwise and remove it
- 3. remove the dirty element (5)
- 4. fit a new FILTREC element (5), verifying the part number, particularly concerning the micron rating; open its plastic protection on the open end side and insert it onto the spigot in the filter head, then remove completely the plastic protection
- 5. clean carefully the bowl; check the O-rings (7) conditions and replace if necessary
- 6. lubricate the bowl's thread (6) and screw it by hand in the filter head (1) by turning it clockwise
- 7. screw in the bowl to stop
-  8. the used filter elements cannot be cleaned and re-used

